

**Standard Features:**

- Advanced unidirectional suspension system
- Premium high-density, high-resiliency foam seat cushions
- Down blend encased cushioning
- Channel detail on back and seat cushions
- Semi-attached back cushions
- Tight seat cushion
- Single-needle top-stitch with thick thread
- Manual articulating headrest
- Manual push-back recline in all seats
- Limited lifetime warranty on frame and suspension
- Ten-year warranty on mechanism
- Quick-ship delivery

**Options:**

- Trillium encased cushioning
- Wood legs available in Dune, Ebony, Mink or Oiled Ash finish
- Contrasting stitch detail available in Bermuda Green, Beige, Black, Brown, Charcoal, Cream, Espresso, Gold Brown, Grey, Lemon, Midnight Blue, and Scarlet thread color

**Additional Power Options:**

- Motorized recliner with an in-arm control panel that is easy to use and includes a USB-C charging port
- Available on seats with an arm (Right and left arms on SO3, both seats on LVS, and seat on RCH)
- SO3 middle seat has Power, Manual, or Stationary options
- Motor and electronics have a three-year warranty
- Lithium-ion battery pack available
- Battery pack has a one-year warranty

Please use actual leather, fabric, Crypton®, Sunbrella® and Ultrasuede® swatches when specifying furniture as the colors shown may vary due to the printing process.

**NOTE:** Please be advised that microfiber fabrics like SUEDELIFE and VEELIFE, and velvet fabrics such as JENSON, REED, and SURI, are not recommended for this style. For a comprehensive list of covers that are NOT suggested, please contact American Leather Support Services. This information can also be found on the fabric landing pages of our website or by scanning the swatch QR code.

Wall Clearance is 16"

Leg height is 2"

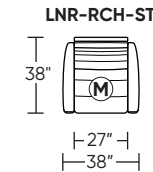
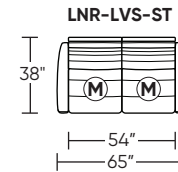
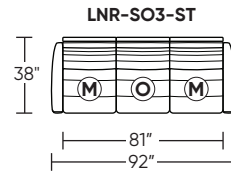
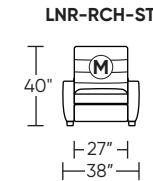
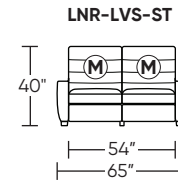
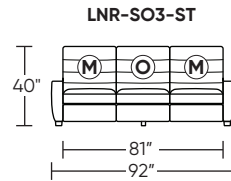
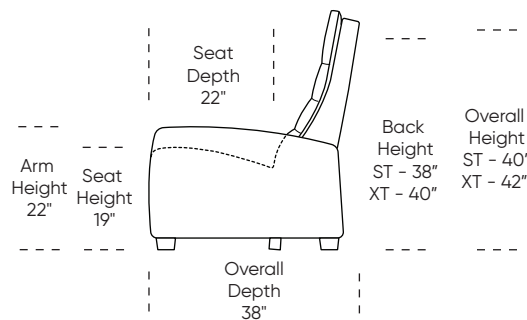

**LNR-SO3-ST**

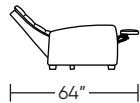

**LNR-LVS-ST**

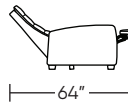

**LNR-RCH-ST**

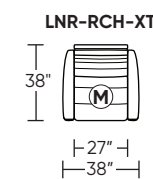
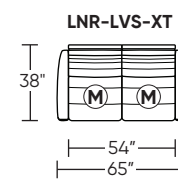
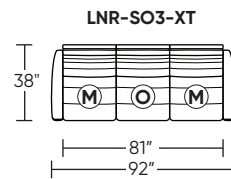
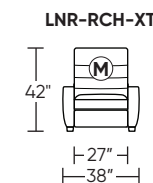
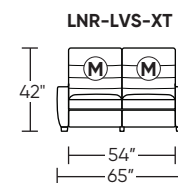
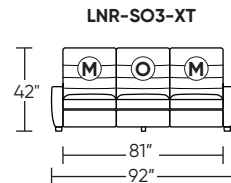
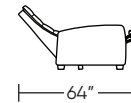

**LNR-SO3-XT**

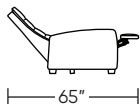

**LNR-LVS-XT**

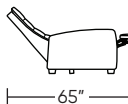

**LNR-RCH-XT**

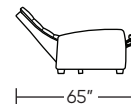

**MOTION LEGEND:**

- (M) = Motion\* only
- (O) = Optional motion\* or stationary

\*Manual and Power motion available

Scale: 1/8 inch = 1 foot  
All dimensions are approximate and subject to change.  
Specify components from the sitting position.